

MECCANO™ Junior

MAKER SYSTEM

*Mighty Cycles!
Super motos!*

16102



 5+

- | | | | |
|---|-------------------------------|---|--------------|
| Ⓔ | Instructions | Ⓒ | Pokyny |
| Ⓕ | Notice de montage | Ⓔ | Pokyny |
| Ⓖ | Instrucciones de construcción | Ⓗ | Útmutató |
| Ⓓ | Bauanleitung | Ⓑ | Instrucțiuni |
| Ⓒ | Bouwinstructie | Ⓔ | Οδηγίες |
| Ⓘ | Istruzioni | Ⓗ | Упуте |
| Ⓗ | Instruções | Ⓒ | Инструкции |
| Ⓒ | Инструкции | Ⓔ | Navodila |
| Ⓒ | Instrukcja | Ⓒ | Talimatlar |



TOOLS INCLUDED / OUTILS INCLUS

HERRAMIENTAS INCLUIDAS / WERKZEUGE ENTHALTEN / GEREEDSCHAAP INBEGREPEN
ATTREZZI INCLUSI / FERRAMENTAS INCLUSAS / ИНСТРУМЕНТЫ ВХОДЯТ В КОМПЛЕКТ
NARZĘDZIA W ZESTAWIE / NÁSTROJE SOUČÁSTÍ BALENÍ / OBSAHUJE NÁSTROJE / SZERSZÁMOK
MELLÉKELVE / INSTRUMENTE INCLUSE / ΠΕΡΙΛΑΜΒΑΝΟΝΤΑΙ ΕΡΓΑΛΕΙΑ / ALAT U PAKETU
ВКЛЮЧЕНИ ИНСТРУМЕНТИ / ORODJE JE PRILožENO / DAHİL OLAN ALETLER



© For information on how this product supports today's STEAM curriculum, visit www.meccano.com.
© Pour découvrir l'intérêt pédagogique de ce produit dans le cadre des matières STEAM, rendez-vous sur www.meccano.com.
© Para mayor información sobre cómo este producto respalda las materias STEAM visita: www.meccano.com.
© Für Informationen, wie dieses Produkt den technisch-mathematischen Lehrplan (MINT) unterstützt, besuchen Sie bitte www.meccano.com.
© Ga naar www.meccano.com voor meer informatie over hoe dit product het huidige STEM-curriculum ondersteunt.
© Per informazioni su come questo prodotto contribuisce ad aiutare i ragazzi nelle materie STEAM "scientifiche, artistiche e tecniche", visitare il sito www.meccano.com.
© Para informações sobre a compatibilidade deste produto com os programas atuais STEAM, acesse www.meccano.com.
© Информация о том, как с помощью этого продукта можно повысить эффективность процесса изучения дисциплин STEAM, представлена на сайте www.meccano.com.
© Aby dowiedzieć się więcej na temat wspierania programu nauczania STEAM przez markę Meccano, odwiedź stronę www.meccano.com.
© Informace o tom, jakým způsobem tento produkt zapadá do studijního programu STEAM, naleznete na webu www.meccano.com.
© Viac informácií o tom, ako tento výrobok podporuje najnovší študijný program STEAM, nájdete na webovej lokalite www.meccano.com.
© A www.meccano.com weboldalon további információkat talál arról, hogy a termék hogyan járul hozzá napjaink STEAM programjához.
© Pentru informații privind modul în care acest produs este compatibil cu sistemul de educație STEAM, vizitați www.meccano.com.
© Για πληροφόριες σχετικά με τον τρόπο με τον οποίο αυτό το προϊόν υποστηρίζει το τωρινό πρόγραμμα της πρωτοβουλίας STEAM, επισκεφθείτε τη διεύθυνση www.meccano.com.
© Informacije o tome kako ovaj proizvod podržava STEAM kurikulum potražite na www.meccano.com.
© За информация относно това как този продукт подкрепя учебната програма STEAM днес посетете www.meccano.com.
© Za več informacij o tem, kako ta izdelek podpira današnje izobraževanje na področju znanosti, tehnologije, inženirstva in matematike (ang. STEAM), obiščite spletno mesto www.meccano.com.
© Bu ürünün, güncel STEAM müfredatını nasıl desteklediğine dair bilgi almak için www.meccano.com adresini ziyaret edin.

TABLE OF CONTENTS / SOMMAIRE

ÍNDICE / INHALTSVERZEICHNIS / INHOUD / INDICE / ÍNDICE / СОДЕРЖАНИЕ / SPIS TREŚCI / OBSAH / OBSAH
TARTALOMJEGYZÉK / CUPRINS / ΠΙΝΑΚΑΣ ΠΕΡΙΕΧΟΜΕΝΩΝ / SADRŽAJ / СЪДЪРЖАНИЕ / VSEBINA / İÇİNDEKİLER LİSTESİ



4



8



11

EN. Content: 49 parts, 2 real tools and 1 instruction sheet for 3 models.

FR. Contenu : 49 pièces, 2 vrais outils et 1 notice de montage pour 3 modèles.

ES. Contenido: 49 piezas, 2 herramientas reales y 1 guía de instrucciones para 3 modelos.

DE. Inhalt: 49 Teile, 2 echte Werkzeuge und 1 Bauanleitung für 3 Modelle.

NL. Inhoud: 49 onderdelen, 2 stuks gereedschap en 1 bouw instructie voor 3 modellen.

IT. Contenuto: 49 pezzi, 2 attrezzi e 1 guida per l'uso per 3 modelli.

PT. Conteúdo: 49 peças, 2 ferramentas reais e 1 folha de instruções para 3 modelos.

RU. В комплекте: 49 деталей, 2 настоящих инструмента и 1 инструкция по сборке 3 моделей.

PL. Zawartość: 49 elementów, 2 prawdziwe narzędzia i 1 karta z instrukcjami dla 3 modeli.

CZ. Obsah: 49 dílů, 2 skutečné nástroje, 1 list s pokyny pro 3 modely.

SK. Obsah: 49 dielov, 2 skutočné nástroje, 1 hárok s pokynmi pre 3 modely.

HU. Tartalom: 49 db alkatrészt, 2 db valódi szerszám és 1 db 3 modellhez tartozó felhasználói útmutató.

RO. Conținut: 49 de piese, 2 instrumente reale, 1 fișă cu instrucțiuni pentru 3 modele.

EL. Περιεχόμενα: 49 κομμάτια, 2 πραγματικά εργαλεία και 1 φυλλάδιο οδηγιών για 3 μοντέλα.

HR. Sadržaj: 49 dijelova, 2 prava alata i 1 list s uputama za 3 modela.

BG. Съдържание: 49 части, 2 истински инструмента и 1 ръководство с инструкции за 3 модела.

SL. Vsebina: 49 delov, 2 pravi orodji in 1 list z navodili za 3 modele.

TR. İçindekiler: 49 parça, 2 gerçek alet ve 3 model için 1 talimat sayfası.

EN. Building instructions are also available at www.meccano.com.

FR. Les notices de montage sont également disponibles sur www.meccano.com.

ES. También hay instrucciones de construcción disponibles en www.meccano.com.

DE. Bauanleitungen sind auch auf www.meccano.com zu finden.

NL. Bouwinstructies zijn ook beschikbaar op www.meccano.com.

IT. Le istruzioni di montaggio sono anche disponibili alla pagina www.meccano.com.

PT. Também estão disponíveis instruções de montagem em www.meccano.com.

RU. Инструкции по сборке можно также найти на сайте www.meccano.com.

PL. Instrukcje montażu można także znaleźć na stronie www.meccano.com.

CZ. Sestavovací pokyny naleznete na webu www.meccano.com.

SK. Pokyny na stavanie sú dostupné na webovej lokalite www.meccano.com.

HU. Az összerakási útmutatókat a www.meccano.com weboldalon is megtalálja.

RO. Instrucțiunile de construire sunt disponibile, de asemenea, la adresa www.meccano.com.

EL. Οι οδηγίες κατασκευής διατίθενται και στη διεύθυνση www.meccano.com.

HR. Upute za sastavljanje dostupne su i na stranici www.meccano.com.

BG. Инструкции относно сглобяването са също налични на www.meccano.com.

SL. Navodila za sestavljanje so na voljo tudi na www.meccano.com.

TR. Birleştirme talimatları, www.meccano.com adresinde de bulunabilir.

EN. Only one model can be built at a time. **FR.** Les pièces fournies ne permettent de monter qu'un seul modèle à la fois. **ES.** Solo es posible construir un modelo a la vez. **DE.** Jeweils nur eins der Modelle baubar.



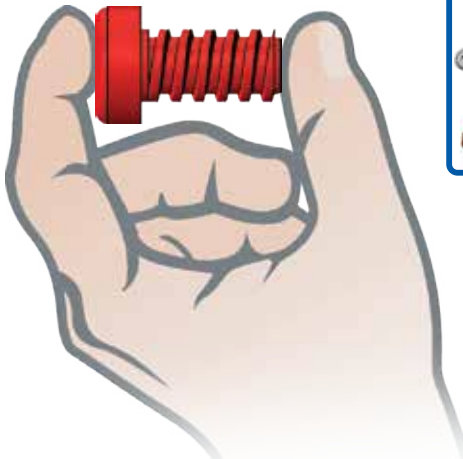
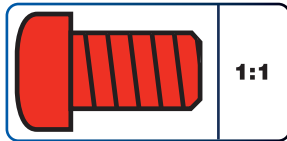

NL. Er kan maar een model tegelijk worden gebouwd. **IT.** Permette di realizzare un solo modello per volta. **PT.** Só é possível montar um modelo de cada vez. **RU.** Одновременно можно построить только одну модель.

PL. Jednocześnie można zbudować tylko jeden model. **CZ.** Najednou lze sestavit pouze jeden model. **SK.** Modely sa dajú vytvoriť len po jednom. **HU.** Egyszerre csak egy modell rakható össze.

RO. Nu pot fi construite mai multe modele în același timp. **EL.** Μπορείτε να δημιουργείτε μόνο ένα μοντέλο κάθε φορά. **HR.** Istovremeno ne možete sastaviti više modela. **BG.** Само един модел може да бъде сглобен едновременно. **SL.** Sestavite lahko samo en model naenkrat. **TR.** Bir seferde yalnızca tek bir model oluşturulabilir.



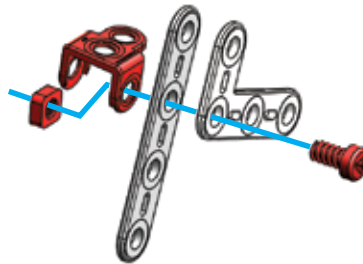

1

	x1
	x1
	x1
	x1
	x1



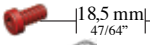

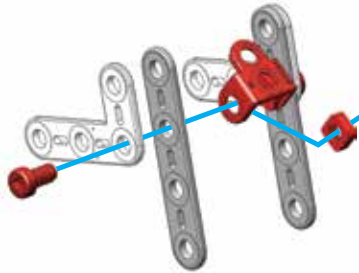
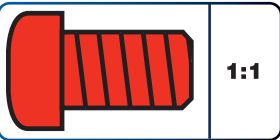

2

	x1
	x1
	x1
	x1

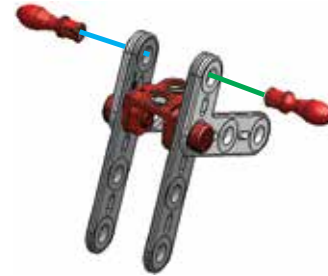

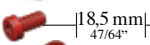

**3**

	x2
---	-----------

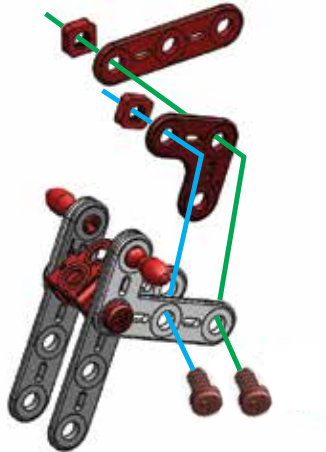
**4**

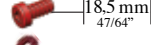

	x1
	x2
	x1
	x2

**5**

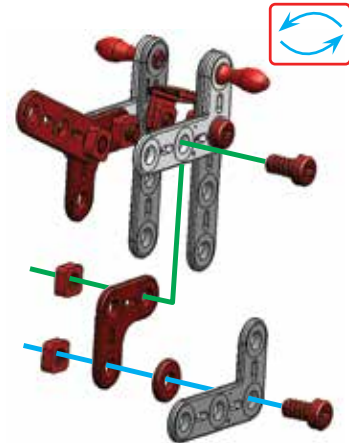
	x1
	x2
	x1
	x2
	x1



6

-  | 34,6 mm | **x1**
125/64
-  **x1**
-  **x1**

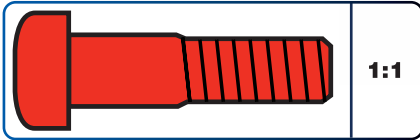
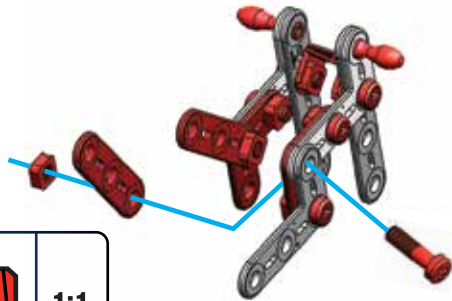

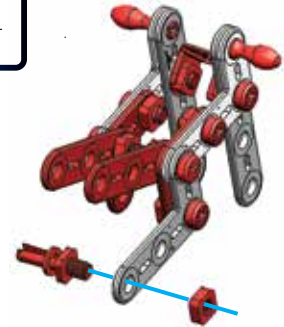

7

-  **x1**
-  **x1**



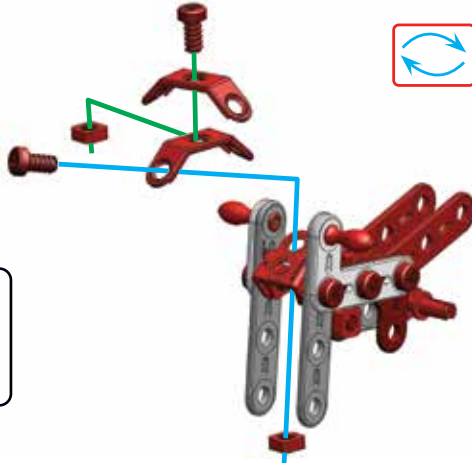

8

-  **x2**
-  | 18,5 mm | **x2**
47/64
-  **x2**



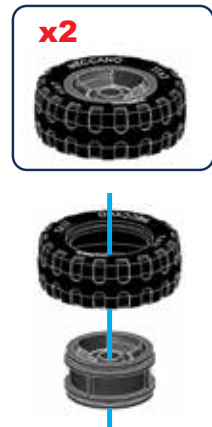

9

-  **x2**
-  **x2**



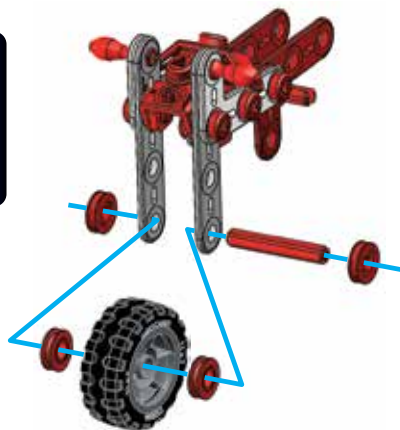

10 ⑧+⑨+

	x1
	x2
	x2



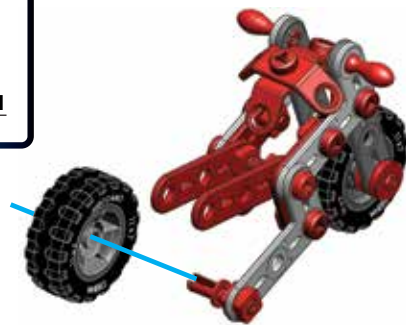

11

	⑨ x1
	⑩ x1



12

	x1
	x2
	x2

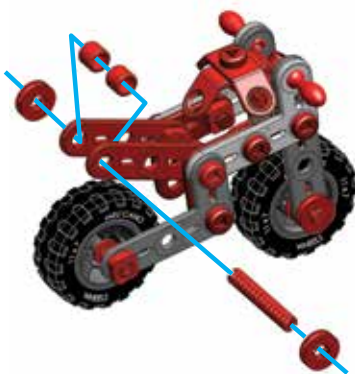



1

	18,5 mm 47/64"	x1
		x1
		x1
		x1

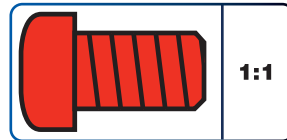

2

		x1
	18,5 mm 47/64"	x1
		x1
		x1
		x1

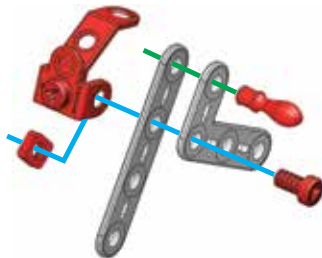



3

		x2
		x2

x2





4 ③+

	x1
	x2





5

	x1
	x1
	x1



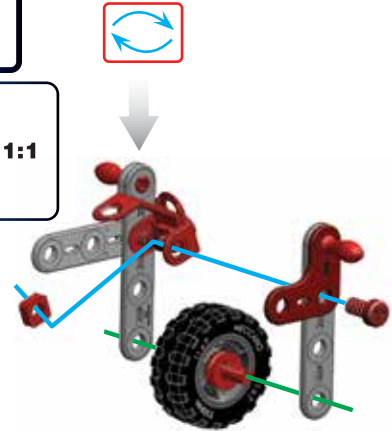
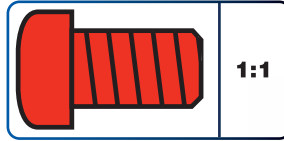

6 ②+④+⑤+

	18,5 mm 47/64" x1
	x1





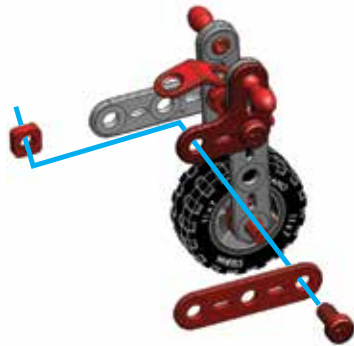

7

	18,5 mm 47/64" x1
	x1
	x1



8

	x1
	18,5 mm 47/64" x2
	x2
	x1

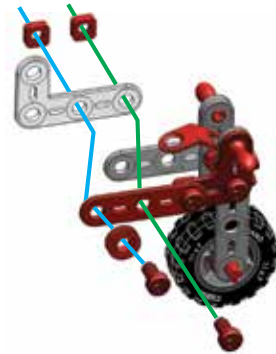

9

	18,5mm 47/64"	x1
		x1
		x1

	1:1
--	------------

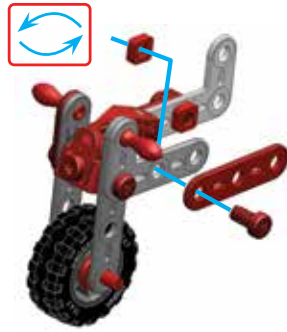

10

	18,5mm 47/64"	x1
		x1
		x1

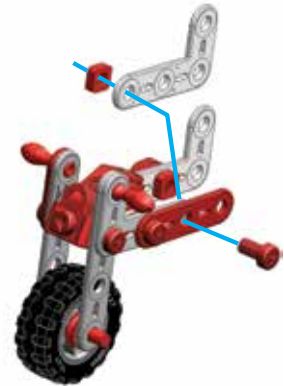

11 ③+⑩+

	x1
	x2
	x2

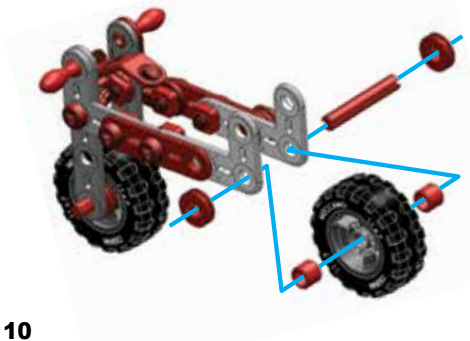



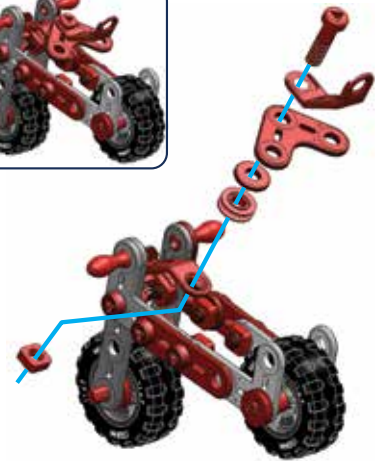

12

	34,6mm 123/64"	x1
		x1
		x1
		x1
		x1





	1:1
--	------------



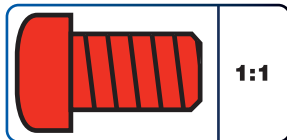
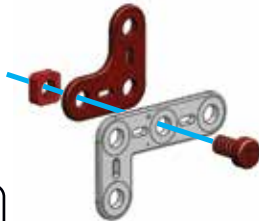

1		x1
		$18,5 \text{ mm}$ $47/64''$ x1
		x1
		x1



2		x1
		$34,6 \text{ mm}$ $123/64''$ x1
		$18,5 \text{ mm}$ $47/64''$ x1
		x2
		x1

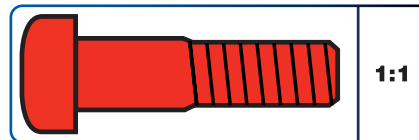
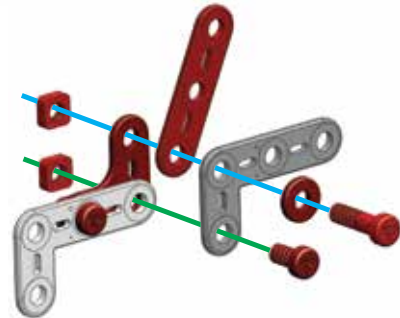

3	
	x1
	x1
	x1
	x1

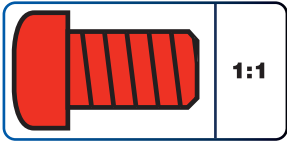

4	②+③+
	x1
	x1
	x1
	x1

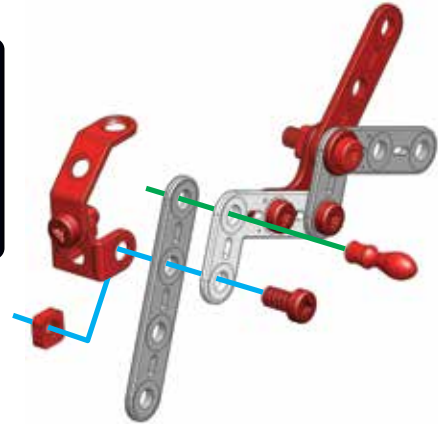

5	
	x1
	x1



6	
	x1
	x2
	x1
	x2

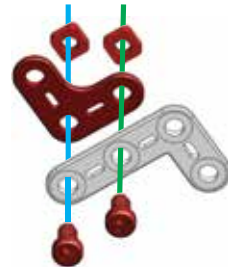

7

	x1
	x1
	x1
	x1
	x1

	1:1
--	------------

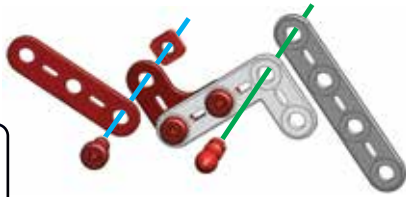

8 (5)+(7)+

	x1
	x1

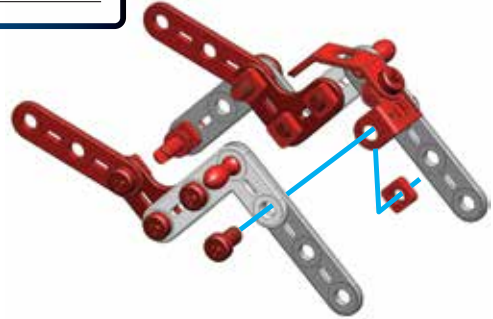

9

	x1
	x2
	x2

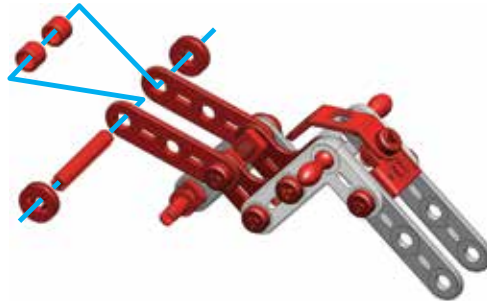

10



11

⑩+⑪+

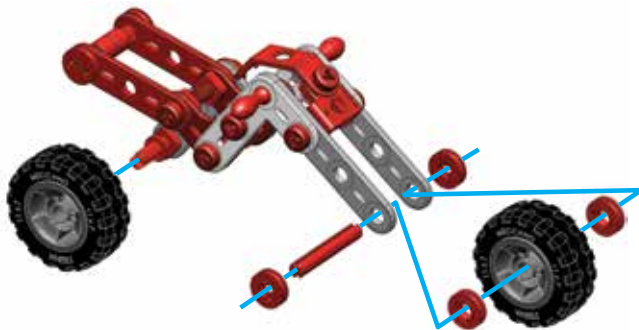
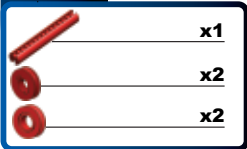



A003 x2



A004 x2



A123 x1



A306 x2



A050 x2



34,6 mm
1 23/64"

A054 x1



18,5 mm
47/64"

A051 x8



A045 x2



A046 x2



A053 x1



A057 x4



A077 x2



C658 x10



A545 x2



A622 x2



A632 x1



A632 x2



B823 x1



B577 x2



A090(MJX0200) x1



A095(J0095) x1

- ⚠ **WARNING:** CHOKING HAZARD – Small parts. Not suitable for children under three years.
- ⚠ **ATTENTION!** DANGER D'ÉTOUFFEMENT – Contient de petits éléments. Ne convient pas aux enfants de moins de trois ans.
- ⚠ **ADVERTENCIA:** PELIGRO DE ASFIXIA – Contiene piezas pequeñas. No conviene para niños menores de tres años.
- ⚠ **ACHTUNG:** ERSTICKUNGSGEFAHR – Kleinteile. Nicht für Kinder unter drei Jahren geeignet.
- ⚠ **WAARSCHUWING:** VERSTIKKINGSGEVAAR – Kleine onderdelen. Niet geschikt voor kinderen jonger dan drie jaar.
- ⚠ **AVVERTENZA:** RISCHIO DI SOFFOCAMENTO – Pezzi piccoli. Non adatto a bambini di età inferiore a tre anni.
- ⚠ **ATENÇÃO:** PERIGO DE ASFIXIA – Peças pequenas. Contra-indicado para crianças com menos de 3 anos.
- ⚠ **ПРЕДУПРЕЖДЕНИЕ!** ОПАСНОСТЬ УДУШЬЯ – Мелкие детали. Не подходит для детей в возрасте до 3 лет.
- ⚠ **OSTRZEŽENIE:** NIEBEZPEČENSTVO ZADLAVIENIA – Drobné elementy. Nie nadaje się dla dzieci w wieku poniżej 3 lat.
- ⚠ **UPOZORNENIE:** NEBEZPEČÍ UDUSENÍ – Obsahuje malé části. Nevhodné pro děti do tří let.
- ⚠ **UPOZORNENIE:** NEBEZPEČENSTVO UDUSENIA – Obsahuje malé predmety. Nevhodné pre deti do troch rokov.
- ⚠ **FIGYELMEZTETÉS:** FULLADÁSVESZÉLY – Apró alkatrészek. Csak három évnél idősebb gyermekek számára alkalmas.
- ⚠ **AVERTISSEMENT:** PERICOL DE ASFIXIERE – Piese mici. Contraindicat copiilor mai mici de trei ani.
- ⚠ **ΠΡΟΕΙΔΟΠΟΙΗΣΗ:** ΚΙΝΔΥΝΟΣ ΠΝΙΓΜΟΥ – Μικρά μέρη. Δεν είναι κατάλληλο για παιδιά κάτω των τριών ετών.
- ⚠ **UPOZORENJE:** OPASNOST OD GUŠENJA – Mali dijelovi. Igračka nije prikladna za djecu mlađu od tri godine.
- ⚠ **ВНИМАНИЕ:** ОПАСНОСТЬ ОТ ЗАДАВЯНИЕ – Малки части. Неподходящо за деца под тригодишна възраст.
- ⚠ **OROZORILQ:** NEVARNOST ZADUSITVE – Majhni deli. Ni primerno za otroke, mlajše od treh let.
- ⚠ **UYARI:** BOĞULMA TEHLİKESİ – Küçük parçalar. Üç yaşından küçük çocuklar için uygun değildir.



Запишите указанные на упаковке адреса и номера телефонов, чтобы у вас была возможность связаться с нами. Рекомендуем присмотр взрослых. Изготовитель: Спин Мастер Лтд., 225 Кинг Стрит Вест, Торонто, ОН М 5В 3М2 Канада ☎1 800 622 8339

Spin Master Ltd., 225 King Street West, Toronto ON M5V 3M2 Canada
 Spin Master Inc., PMB #10053, 300 International Drive, Suite 100, Williamsville, NY 14221
 Spin Master International B.V., Kingsfordweg 151, 1043 GR Amsterdam, NL
 Spin Master Australia Pty Ltd, Suite 101, Level 1, 18-24 Chandos Street, St Leonards, NSW 2065; ☎1800 316 982
 Spin Master Toys UK Ltd, Secure Trust House, Boston Drive, Bourne End, Buckinghamshire, SL8 5YS, UK
 Импортёр: ООО «Спин Мастер РУС», Россия, Москва 117638 Одесская ул. 2, Бизнес-центр «Лотос», башня С, 10 эт. Тел.: 8 800 301 38 22

TM & © 2017 MECCANO for packaging, instructions and models built with this set. © MECCANO is an exclusive trademark of MECCANO. Spin Master logo is a trademark of Spin Master Ltd. All rights reserved. / TM & © 2017 MECCANO pour l'emballage, les notices et modèles de ce coffret. © MECCANO est une marque de commerce exclusive de MECCANO. Le logo de Spin Master est une marque de commerce de Spin Master Ltd. Tous droits réservés.

Meccano reserves the right to discontinue the website www.meccano.com at any time. Meccano se réserve le droit de supprimer le site Internet www.meccano.com à tout moment.

www.spinmaster.com
 Meccano : 363, avenue de Saint Exupéry 62100 Calais - France

ASSEMBLED IN FRANCE. PARTS MADE IN CHINA AND FRANCE.
 ASSEMBLÉ EN FRANCE. PIÈCES FABRIQUÉES EN CHINE ET EN FRANCE.
 ENSAMBLADO EN FRANCIA. PIEZAS FABRICADAS EN CHINA Y EN FRANCIA.
 СОБРАНО ВО ФРАНЦИИ. ДЕТАЛИ СДЕЛАНЫ В КИТАЕ И ВО ФРАНЦИИ.
 FRANSA'DA BİRLEŞTİRİLMİŞTİR. PARÇALAR ÇİN VE FRANSA'DA ÜRETİLMİŞTİR.



T91810_0005_20071405_GML_IS_R60 (MEC_Junior_Motorcycle_V2_Fr)

UK – 0800 206 1191, serviceuk@spinmaster.com
IRELAND – 1800 992 249
FRANCE – 0800 909 150, servicefr@spinmaster.com
AUSTRALIA – 1800 316 982, customercare@spinmaster.com
DEUTSCHLAND – 00800 0101 0222, Kundenservice@spinmaster.com
SCHWEIZ – 0800 561 350 • ÖSTERREICH – 0800 297 267
NEDERLAND – 0800 022 3683, klantenservice@spinmaster.com
BELGIË/BELGIQUE – 0800 77 688 • LUXEMBOURG – 800 2 8044

ITALIA – 800 788 532, servizio@spinmaster.com
MÉXICO – 01 800 9530147, servicio@spinmaster.com
POLSKA – 800080238, poland@spinmaster.com
ČESKÁ REPUBLIKA – 800550530, czechrepublic@spinmaster.com
SLOVENSKO – 0800232800, slovakia@spinmaster.com
MAGYARORSZÁG – 080 100 052, hungary@spinmaster.com
ROMÂNIA – 0800400015, romania@spinmaster.com
РОССИЯ – 88003013822, russia@spinmaster.com



NORTH AMERICA • AMÉRIQUE DU NORD 1-800-622-8339, CUSTOMERCARE@SPINMASTER.COM WWW.SPINMASTER.COM